

Technisches Datenblatt

Fächerscheibe DIN 6798 A2

Artikelnummer: 3404331



Fächerscheibe nach DIN 6798, Form A.



A2 **A4** **A5** Edelstahl, rostfrei Edelstahl, rostfrei Edelstahl, rostfrei

2B blank, nachbehandelt

Stammdaten

Artikelnummer	3404331
Typ	SWS M6 A2
Bezeichnung 1	Fächerscheibe
Hersteller	OBO
Dimension	M6
Werkstoff	Edelstahl, rostfrei
Oberfläche	blank, nachbehandelt
Oberflächennorm	
Kleinste VK-Einheit	100
Mengeneinheit	Stück
Gewicht	0,04 kg
Gewichtseinheit	kg/100 St.

Technisches Datenblatt

Fächerscheibe DIN 6798 A2

Artikelnummer: 3404331



Abmessungen

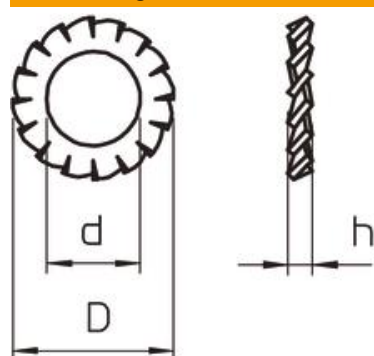

Höhe	2,1 mm
Blechstärke	0,08 in
Maß D	0,43 in
Maß d	0,25 in
Maß d	6,4 mm
Maß D min.	11 mm
Maß h	2,1 mm

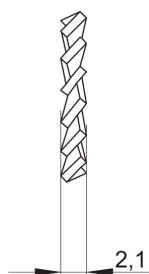
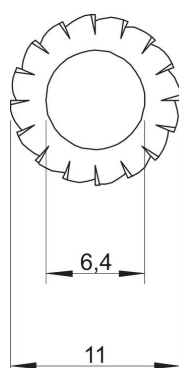
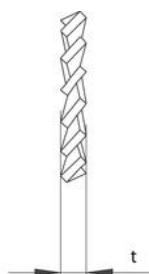
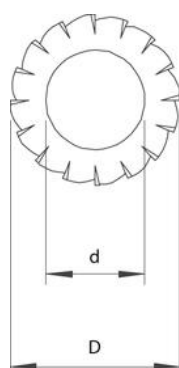
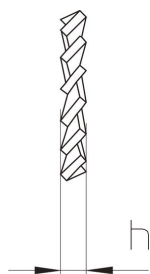
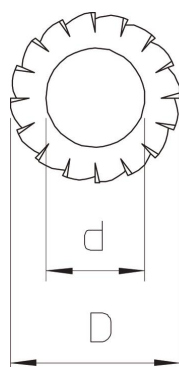

Technisches Datenblatt

Fächerscheibe DIN 6798 A2

Artikelnummer: 3404331



Technische Daten

Gewinde	M6
Innendurchmesser	0,25 mm
Ausführung Sicherungsscheibe	offene Außenverzahnung