

Technical data sheet

Wall and support bracket, angle head

Item number: 6419856



Heavy-duty wall and support bracket with welded angle head plate, for fastening to walls or structures.

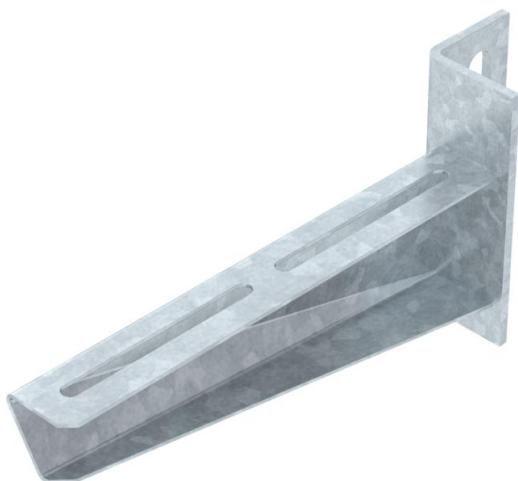

CE

St Steel

FT Hot-dip galvanised

Master data

Item number	6419856
Type	AW 30 21 WK FT
Description 1	Wall and support bracket
Description 2	with angle head plate
Manufacturer	OBO
Dimension	B210mm
Material	Steel
Surface	Hot-dip galvanised
Surface standard	DIN EN ISO 1461
Smallest sales unit	1
Unit of quantity	Piece
Weight	49.6 kg
Weight unit	kg/100 pc.

Technical data sheet

Wall and support bracket, angle head

Item number: 6419856



Dimensions

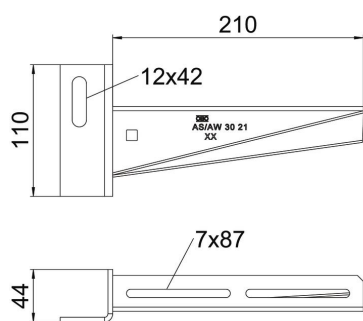

Width	210 mm
Height	110 mm
Dimension A	44 mm

Technical data

Version for	Wall and support bracket
Maintain electrical functions	no
Rustproof steel, pickled	no
Angle range, max.	90 mm
Angle range, min.	90 mm